

Instant™ Ace Plus



User Manual

- Important Safeguards
- Product Specifications
- What's Included
- Product Overview
- Getting Started
- Controls & Features
- Stacking Food Ingredients
- Blending Programs
- Tamping Food Ingredients
- Care & Cleaning
- Troubleshooting
- Warranty

Download the Free Instant Pot Recipe App

- Original Recipes
- New User Tips
- Getting Started Videos



Welcome to the World of Instant[™] Cooking

Thank you for welcoming us into your kitchen.

Having families ourselves, we developed the Ace Plus to allow busy families and professionals alike to cook healthy, delicious meals more easily and in less time.

We have partnered with chefs, authors and bloggers to compile a collection of recipes that we hope you enjoy!

Happy Cooking!

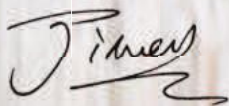

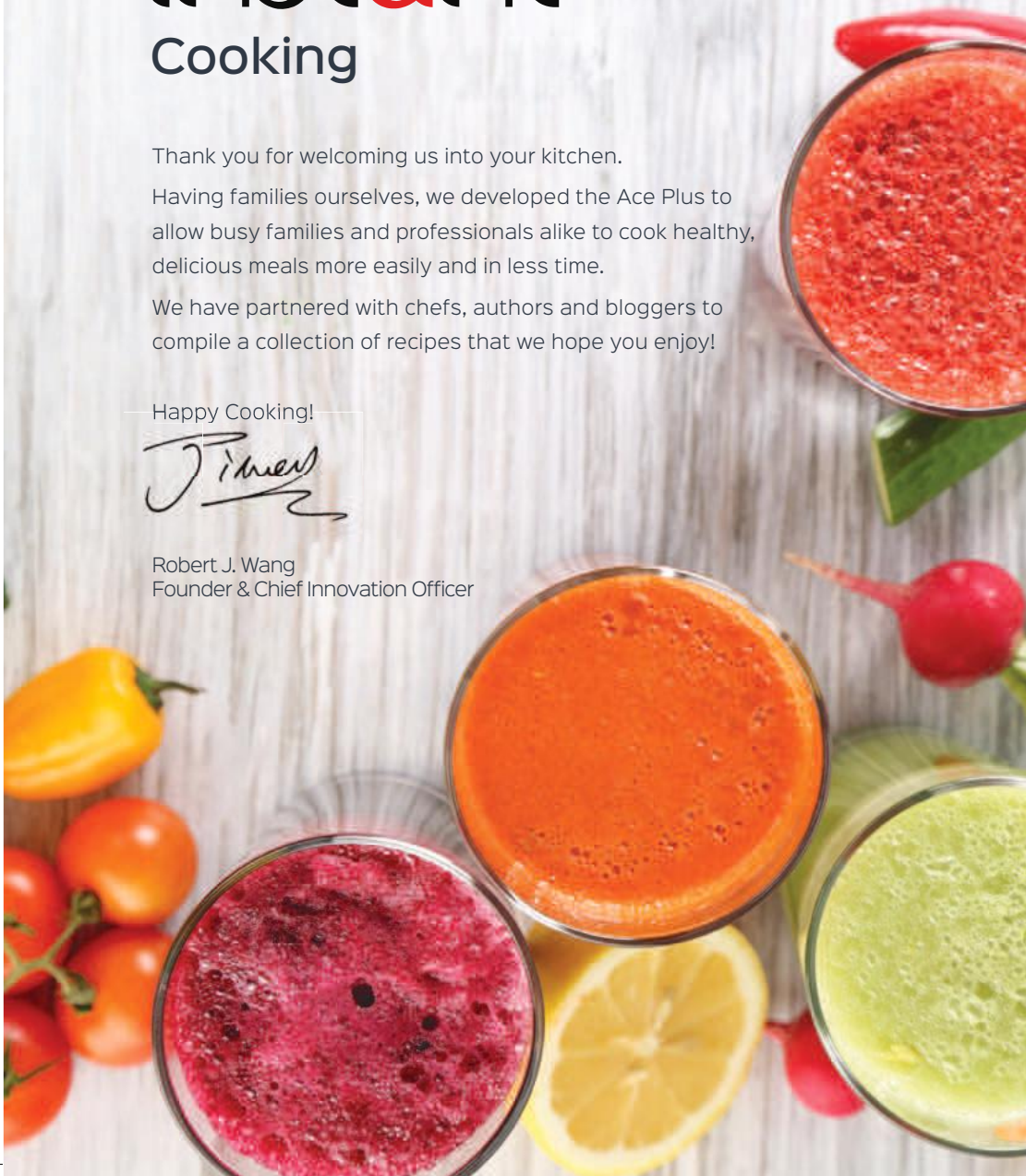

Robert J. Wang
Founder & Chief Innovation Officer



IMPORTANT SAFEGUARDS



When using electrical appliances, basic safety precautions should always be followed:

1. READ ALL INSTRUCTIONS, SAFEGUARDS, AND WARNINGS BEFORE OPERATING BLENDER.
2. Always operate the appliance on a horizontal surface that is level, stable, and non-combustible.
3. Do not touch hot surfaces. Handle with care and always use handle on side of pitcher for carrying.
4.  To protect against electrical shock, fire, or personal injury, do not immerse power cord, plug, or blender base in water or other liquid.
5. Close supervision is necessary when any appliance is used by or near children. Children should be supervised to ensure they do not play with the appliance.
6. To disconnect, select Cancel, then unplug from outlet when not in use, before assembling or disassembling parts and before cleaning. To unplug, grasp the plug and pull from the outlet. Never pull from the power cord.
7. Flashing light indicates blender is ready to operate. Avoid inadvertent contact with the touch screen.
8. Allow the unit to cool before putting on or taking off parts and before cleaning. Proper maintenance is recommended after each use. Refer to “Care & Cleaning”.
9. Do not operate any appliance with a damaged cord or plug or after the appliance malfunctions, or is dropped or damaged in any manner. This appliance has important markings on the plug blade. The attachment plug and/or cord set is not suitable for replacement. If damaged, the appliance must be replaced. Contact Customer Care for warranty information.
10. Do not use any accessories or attachments not authorized by Instant Brands Inc. The use of attachments not recommended by the manufacturer, such as spatulas or tampers, may result in fire, electric shock or injury to persons.
11. For household countertop use only. Do not use outdoors. Not for commercial use.
12.  Do not let cord hang over edge of table or counter, or contact hot surface, including the stove.
13. Do not place the appliance on or in close proximity to a hot gas or electric burner, or a heated oven; heat from an external source will damage the appliance.
14. Extreme caution must be used when moving the appliance containing hot liquids.



Read this manual carefully and completely, and retain for future reference.
Failure to adhere to safety instructions may result in serious injury.



IMPORTANT SAFEGUARDS

15. Do not use appliance for other than intended use.
16. Blades are sharp. Avoid contact with blades and moving parts. Handle with care.
17. The blades are not removable from the pitcher. Do not attempt to disassemble the blade assembly. Failure to follow this direction may cause injury.
18. Do not attempt to operate the blender with damaged blades.
19. This product is not designed to deep fry.
20. To avoid spill or splatter, do not fill the pitcher beyond measurement indicators.
21.  Pitcher will be hot after cooking. Allow sufficient cooling down time before handling or serving. Keep hands away from hot glass and use side handle for carrying. Failure to comply may result in scalding or serious injury.
22. When making nut butters or oil-based foods, processing for long periods can cause dangerous overheating. After the Smart Program completes, do not process for more than 2 additional minutes.
23. Never blend carbonated beverages. Built-up pressure from released gases can cause the pitcher to overflow, resulting in possible property damage and/or injury.
24. Always operate blender with lid in place. The lid and/or lid cap should only be removed when the blender is off or Paused, in order to add ingredients to the pitcher or use the food tamper.
25.  Spilled food can cause serious burns. Keep appliance and cord away from children. Never drape cord over edge of counter, and never use power outlet below counter.
26. Do not attempt to repair, replace, alter, or modify components of the appliance, as this may cause electric shock, fire or injury, and will void the warranty.
27. Do not tamper with any of the safety mechanisms.
28. Do not use unit in electric systems other than 120V~60Hz for Canada & USA. Do not use with power converters or adapters.
29. Never remove or rock the pitcher/lid during operation.
30. Keep hands and utensils out of pitcher while blending to reduce the risk of severe injury to persons or damage to the blender. The lid must remain in place when using the food tamper through the lid opening. A scraper may be used but must be used only when the blender is not running.



Read this manual carefully and completely, and retain for future reference.
Failure to adhere to safety instructions may result in serious injury.

IMPORTANT SAFEGUARDS

31. Never put non-food items, such as metal, glass, plastic or wood, in the blender, as this may damage the blades and other components of the blender. Failure to remove foreign objects from blender may break the glass pitcher, or cause injury.
32.  The vented lid cap must be in place when using hot blending programs, or when blending hot contents. Spray, steam, or spatter may cause scalding burns if the lid or lid cap is removed when blending hot contents. Do not overfill pitcher. Keep hands away from lid openings to prevent burns.
33. Do not operate the blender while the pitcher is empty.
34. Do not leave appliance unattended while in use.
35.  Lids and tampers are not interchangeable between different blenders.
36. Prior to each use, inspect appliance for cracks or other damage. Do not use if the lid, lid cap, pitcher, or blender base is cracked or damaged, and contact Customer Care.
37. This appliance is NOT to be used by children or by persons with reduced physical, sensory, or mental capabilities. Close supervision is necessary when any appliance is used near children. Children should not play with this appliance.

SAVE THESE INSTRUCTIONS.

WARNING

To avoid injury, read and understand instruction manual before using this appliance.

WARNING

Electrical Shock Hazard. Use grounded outlet only. **DO NOT** remove ground. **DO NOT** use an adapter. **DO NOT** use an extension cord. Failure to follow instructions can cause death or electrical shock.

NOTICE

THE FAILURE TO FOLLOW ANY OF THE IMPORTANT SAFEGUARDS AND THE IMPORTANT INSTRUCTIONS FOR SAFE USE IS A MISUSE OF YOUR BLENDER THAT CAN VOID YOUR WARRANTY AND CREATE THE RISK OF SERIOUS INJURY.

Product Specifications



Model: Ace Plus



Heating: 800W
Blending: 1300W



120V ~ 60 Hz



1.6 Litres
56 Ounces



12.8 lbs
5.8 kg



in: 9.8L x 9.1W x 16.7H
cm: 24.9L x 23.1W x 42.6H

WARNING

Read this manual carefully and completely, and retain for future reference.
Failure to adhere to safety instructions may result in serious injury.

What's Included

Before using the Instant Ace Plus verify that all parts are accounted for. Read instructions carefully, and pay attention to Important Safeguards and operation instructions. Do not remove safety stickers from blender base, pitcher, or lid. Do not remove rating label from blender base.



Lid



Glass Pitcher



Base



3-in-1 Food Tamper
(Tamper / Measuring Cup / Cleaning Brush)



Strainer Bag

Product Specifications

Lid

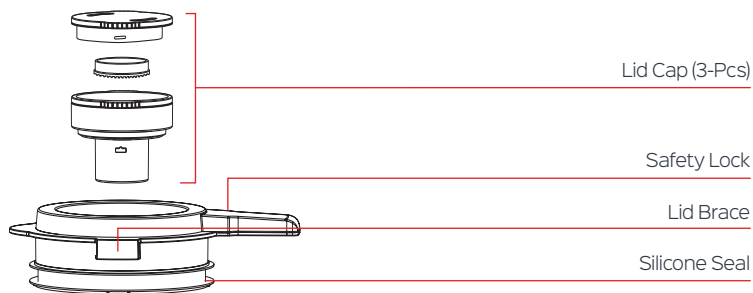

Glass Pitcher

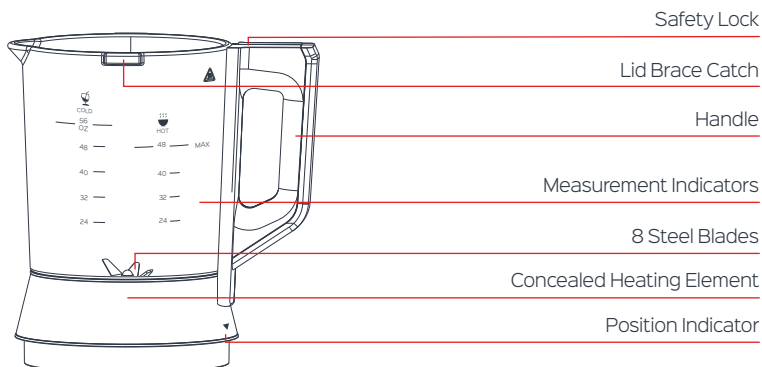

Blender Base

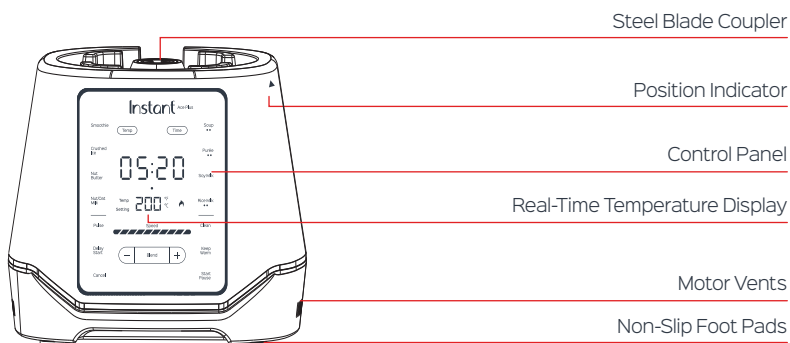

Getting Started

Before using your Instant Ace Plus, follow the steps below to clean the pitcher and lid.

1 Read Manual & Place Blender

Do not remove safety stickers from blender base, pitcher, or lid.
Do not remove rating label from bottom of blender base.
Place blender base on a stable surface.

CAUTION Do not place appliance on or in close proximity to a hot gas or electric burner, or a heated oven; heat from an external source will damage appliance.

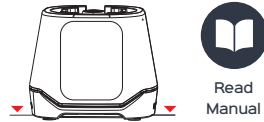

2 Secure Power Cord

Connect to a 120V power source.
Display will remain blank until pitcher is in place on blender base.



3 Fill Pitcher with Water

With the lid removed, fill with hot water to 32 oz / 1000 mL as indicated on the pitcher.



4 Secure Lid

Place lid on pitcher and turn lid clockwise until it clicks into place.
Lid braces must fit over glass lid brace catches, located on pitcher.

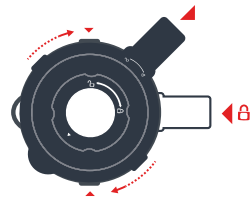

5 Place Pitcher

Place the glass pitcher on blender base by aligning the position indicator ▼ near the bottom of the pitcher to the position indicator ▲ near the top of the base. Display will indicate "OFF".

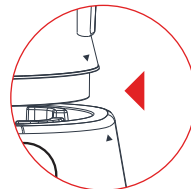

Getting Started

6 Add Dish Soap

Turn lid cap counter-clockwise to remove lid cap from lid.

Add a few drops of dish soap to pitcher.

Fit lid cap into lid and turn clockwise until it clicks into place.

CAUTION

Add a minimal amount of dish soap to the pitcher. Too much dish soap results in excess foam, which may cause the pitcher to overflow.

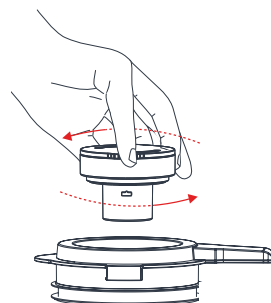

7 Select Program

Touch **Clean**.

Touch **Start**.

Blender will run high speed cycles, pausing between pulses.

When Program has completed, display will indicate "End".

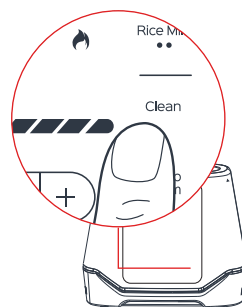

8 Empty Pitcher

Lift the pitcher up and off the blender base.

When pitcher is removed from blender base, display will go blank.

Turn the lid counter-clockwise and lift up and off the pitcher.

Discard soapy water and rinse pitcher, lid, and lid cap with warm, clear water.



WARNING

Do not reach into pitcher while blender is in use. Rotating blades can cause damage and serious injury. Do not put hands, spatulas, or any other utensil into pitcher while blender is running.

Controls & Features

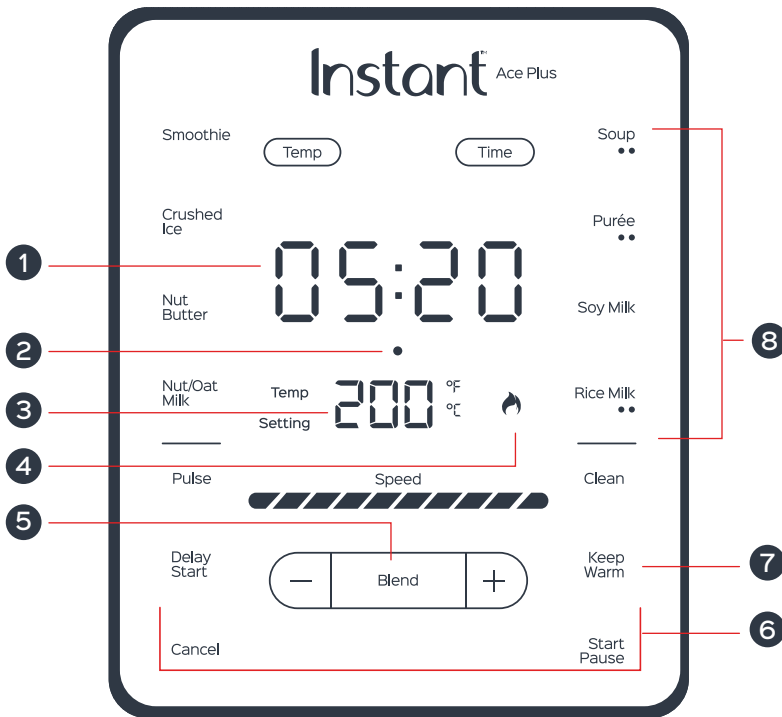

Memory Function

The Instant Ace Plus contains an embedded microprocessor that remembers your preferences within each Smart Program, allowing you to experiment and fine-tune settings for personalized cooking results.

Smart Program Reset

When in Standby, touch and hold the Smart Program key until the blender beeps.

Full Default Reset

When in Standby, touch and hold **Cancel** until the cooker beeps.

Controls & Features

1 Smart Program Time Display

Smart Programs appear in minute format
Keep Warm & Delay Start appear in hour format

2 Error Indicator

If error occurs, light will blink and error code will be displayed on the screen

3 Real-Time Temperature Display

During hot blending programs, real-time temperature is displayed in Fahrenheit (°F) or Celsius (°C).

To change displayed temperature from °F to °C, first press **Cancel** to ensure the blender is in Standby. Next, press and hold **Pause** for 5 seconds. Blender will beep once and display the selected temperature

4 Heat Indicator

Illuminates when the heating element is engaged

5 Blend

Up to 5 minutes of continuous blending
10 speeds shown on display

6 Control Keys

- **- / + keys:** Use to adjust time, temperature and speed – touch and hold to adjust quickly.
- **Start / Pause:** Touch to begin program. Touch again to pause program. Display will indicate “-P-” when paused. Touch again to resume

Note: If the lid is removed during blending, or the pitcher is removed from the blender base, the blender will automatically pause the program. When ready to resume, secure lid and press Start/Pause

- **Cancel:** Stop the program and return to Standby (“OFF”)
- **Pulse:** Adjustable 10-speed pulse motion blending
- **Clean:** Pre-programmed high speed pulse cycles
- **Time:** Set a custom program time
- **Temp:** Set a custom temperature on **Soup**, **Purée** & **Keep Warm**

7 Smart Programs Settings

- **Keep Warm:** Serving temperature is maintained for up to 2 hours
- **Delay Start:** Postpone a program up to 12 hours

8 Smart Programs

Cold Blending Programs	Hot Blending Programs
Smoothie	Purée ••
Crushed Ice	Soy Milk
Nut Butter	Rice Milk ••
Nut / Oat Milk	Soup ••

Note: Blending Program keys with 2 dots (••) on them can toggle between options 1 & 2. See “Hot Blending” section in this manual. Control panel will go black/blank after 30 minutes of inactivity. Touch any key, or re-seat the pitcher to illuminate display.

Stacking Food Ingredients

When blending cold ingredients, the order in which ingredients are placed in the pitcher may affect the blender's performance. It is best to add the liquid ingredients first and then add the dry ingredients after.

Stacking Order

- 1 Liquids
- 2 Powders & Sweeteners (protein, fiber, etc.)
- 3 Leafy Greens (remove ribs and stems)
- 4 Soft Ingredients (yogurt, nut butter, tofu, etc.)
- 5 Fresh Fruit, Nuts & Seeds
- 6 Frozen Fruit & Ice Cubes

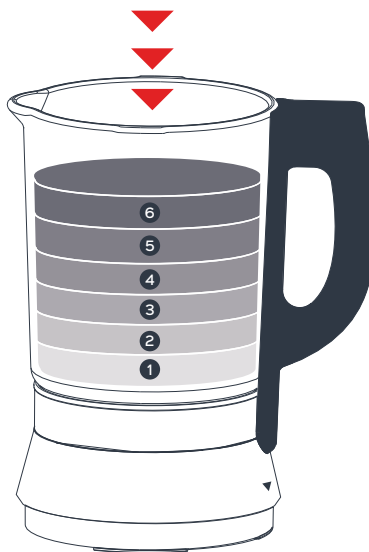

INSTANT TIP: One-Pitcher Performance

Follow the stacking guide above for optimal blending results, and to ensure your blender's longevity.

Manual Blending

Blend continuously at the selected speed for up to 5 minutes.

Minimum* Liquid	Maximum* Cold Contents	Maximum* Hot Contents	Maximum* Dry Contents
1/4 cup / 2 oz / 60 mL	56 oz / 1600 mL	48 oz / 1400 mL	32 oz / 1000 mL

**Minimum and maximum content guidelines are recommendations. For specific instruction, refer to a trusted recipe.*

1. Connect power cord to a 120V power source.
2. Add recipe ingredients to pitcher. For cold ingredients, refer to “**Stacking Food Ingredients**” section in this manual.
3. Place lid on pitcher and turn lid clockwise until it clicks into place. Lid braces must fit over glass lid brace catches, located on pitcher.
4. Place pitcher on blender base.
5. Touch **Blend**.
6. Use **+ / -** to adjust speed.
7. Touch **Start**. Blades turn at selected speed and timer counts up.
8. Touch **Cancel** once desired consistency is reached.
Note: To prevent overheating, blades will not turn for longer than “05:00” minutes.
9. When program has completed, blender will beep 10 times and display will show “**End**”.
10. Remove lid and serve.

Blending Dry Ingredients

When blending dry goods, make sure the pitcher, blades, lid & lid cap are completely dry.

Size of Dry Ingredient	Blend Speed
Smaller than 1/2 inch / 1.25 cm	7-10
Larger than 1/2 inch / 1.25 cm	4-6

Dry blend in the Instant Ace Plus

- Pulverize dried bread to make breadcrumbs
- Crush nuts, seeds, Graham crackers or cookies for crusts & toppings
- Grind your own flour from oats, rice, wheat berries, corn & more
- Crumble chocolate for toppings
- Rough chop dried fruit

CAUTION

To prevent risk of injury or damage to the blender, do not attempt to grind hard, non-food items such as wood, glass, stone, plastic or metal.

Pulse Blending

Adjustable 10-speed pulse motion blending for quick food processing.

Fixed-Pattern Pulse Program

1. Connect power cord to a 120V power source.
2. Add recipe ingredients to pitcher. For cold ingredients, refer to “**Stacking Food Ingredients**” section in this manual.
3. Place lid on pitcher and turn lid clockwise until it clicks into place. Lid braces must fit over glass lid brace catches, located on pitcher.
4. Place pitcher on blender base.
5. Touch **Pulse**.
6. Use **+ / -** to adjust speed.
7. Touch **Start**. Blades will pulse as timer counts down.
8. Touch **Cancel** once desired consistency is reached, or wait until program completes.
9. When program has completed, blender will beep 10 times and display will show “**End**”.
10. Remove lid and serve.

Quick Pulse

Manual Pulse control.

1. Follow steps 1-4 in “**Pulse Blending**” section above.
2. Touch and hold **Pulse** for 5 seconds to switch to manual pulse control. Display will count up from “**00:00**” and blades will turn as long as you are touching **Pulse**.
3. Remove your finger from **Pulse** to stop blending. Display will indicate **-P-** between pulses.
4. If desired, use **+ / -** to adjust pulse motion speed.
5. Touch to **Pulse** as needed.

Cold Blending

Cold blending programs blend at different intervals throughout the countdown. Whip up smoothies, crush ice for summer drinks, and create delicious homemade nut butters and nut or oat milk.

Note: The blender will not cool or freeze food items. For smoothies and cold treats use chilled and frozen ingredients, and tamp often.

Minimum* Liquid	Maximum* Cold Contents
1/4 cup / 2 oz / 60 mL	54 oz / 1600 mL

*Minimum and maximum content guidelines are recommendations. For specific instruction, refer to a trusted recipe.

Blending Program	Foods
Smoothie	Fresh or frozen fruits, berries, seeds, yogurt
Crushed Ice	Designed to crush ice
Nut Butter	Almond, cashew, peanut, hazelnut, sunflower seed
Nut / Oat Milk	Almond, oat, cashew, pumpkin seed, flax, hazelnut, hemp

1. Connect power cord to a 120V power source.
2. Add recipe ingredients to pitcher according to “**Stacking Food Ingredients**” section in this manual.
3. Place lid on pitcher and turn lid clockwise until it clicks into place. Lid braces must fit over glass lid brace catches, located on pitcher.
4. Place pitcher on blender base.
5. Touch a cold blending program: **Smoothie, Crushed Ice, Nut Butter, Nut/Oat Milk**.
6. Use **+ / -** to customize program time.
7. Touch **Start**. Blades will stir as timer counts down.
8. Touch **Cancel** to stop blending, or wait for countdown to complete.
9. When program has completed, blender will beep 10 times and display will show “**End**”.
10. Remove lid and serve.

CAUTION

When blending thick contents, do not fill the pitcher higher than 32 oz / 1000 mL to avoid overheating the motor.

Hot Blending

Hot blending programs combine boiling and blending for optimal one-pitcher performance. Cook fresh ingredients, or blend hot, steamed and pre-cooked ingredients into soups, purées, baby food and more.

Note: These programs apply a gentle-blending start, then add an intermittent quick-stir motion to agitate food contents throughout the cooking program.

Minimum* Liquid	Maximum* Hot Contents
1/4 cup / 2 oz / 60 mL	48 oz / 1400 mL

*Minimum and maximum content guidelines are recommendations. For specific instruction, refer to a trusted recipe.

Blending Program		Foods
Purée	•	Hard vegetables – carrot, potato, Brussels sprouts
	••	Soft fruits & vegetables – tomato, spinach, onion
Rice Milk	•	White rice milk
	••	Brown rice milk
Soy Milk	-	Soy milk
Soup	•	Chunky soup
	••	Creamy soup

1. Connect power cord to a 120V power source.
2. Add recipe ingredients to glass pitcher according to “**Stacking Food Ingredients**” section in this manual.
3. Place lid on pitcher and turn lid clockwise until it clicks into place. Lid braces must fit over glass lid brace catches, located on pitcher.
4. Place pitcher on blender base.
5. Touch a hot blending program: **Purée**, **Soy Milk**, **Rice Milk**, **Soup**. If applicable, press the same key again to toggle between options **1** & **2**. Refer to chart above.
6. Use **+ / -** to customize program time.
7. Touch **Temp** and use **+ / -** to set a custom cooking temperature.

Note: *Rice Milk & Soy Milk temperatures cannot be adjusted.*
8. Touch Start. Display will indicate real-time temperature as contents heat. Blades will stir intermittently while heating, as well as throughout the countdown.

Note: *When the blender pulses, you may see the real-time temperature drop. This is normal.*
9. Cook time countdown will begin once target temperature is reached.
10. When program has completed, blender will beep 10 times and display will show “**End**”.
11. Carefully remove lid and serve.

WARNING

Removing the lid cap when blending hot contents may result in scalding injury. To tamp hot contents, press **Pause** or turn the blender off by pressing **Cancel**, then remove the lid completely before inserting tamper.

The pitcher will be hot during and after cooking. To avoid burns, do not touch the hot surfaces. Use the handle on the side of the pitcher to carry and pour.

Tamping Food Ingredients

The food tamper may be used when blending cold food and liquid ingredients. Use the tamper to push food from sides of pitcher, or release air bubbles that may form during blending.

When inserted through the lid opening, the guard near the top of the tamper prevents the tamper from making contact with the blades.

1. Depending on contents, follow steps 1-7 in “**Cold Blending**” or steps 1-8 in “**Hot Blending**” sections of this manual.
2. Touch **Pause**.
3. Turn lid cap counter-clockwise to remove lid cap from lid.
4. Insert the food tamper through the lid opening.
5. Push food down from sides of pitcher towards blades.
6. Fit lid cap into lid and turn clockwise until it clicks into place.
7. Touch **Pause** to resume program.

WARNING

Do not reach into pitcher while blender is in use. Rotating blades can cause damage and serious injury. Do not put hands, spatulas, or any other utensil into pitcher while blender is running.

Lids and tampers are not interchangeable between different blenders. Only use accessories and small parts included with purchase.

Keep Warm

Keep Warm is automatically applied to all “**Hot Blending**” programs. Once cooking completes, the blender will keep contents warm for up to 2 hours.

To turn the setting off, select your blending program and touch **Keep Warm**.

1. Follow steps 1-7 in “**Hot Blending**” section of this manual.
2. **Keep Warm** will be on automatically.
3. Touch **Start**. To turn **Keep Warm** off, touch **Keep Warm**.
4. When **Keep Warm** turns on, cook time display will count up.

Manual **Keep Warm** can be used from Standby to warm contents.

1. From Standby (“**OFF**”), touch **Keep Warm**.
2. Use **+/-** to customize program time.
3. Touch **Temp** and use **+/-** to set a custom temperature.
4. Touch **Start**.

Delay Start

Delay Start offers the option to postpone “**Hot Blending**” programs for up to 12 hours.

1. Follow steps 1-7 in “**Hot Blending**” section of this manual.
2. Touch **Delay Start**.
3. Use **-/+** to choose how long to delay the program. “**06:00**” (6 hours) is default.
4. Touch **Start** to begin, and **Delay Start** timer will count down.

Care & Cleaning





Unplug when not in use, and allow to cool before cleaning or storage. Clean after each use.

Part	Cleaning Method		Cleaning Tip
	Dishwasher Safe (Immersible)	Hand Wash Only (Do not immerse)	
Lid (3 pcs)	✓		If dishwashing, place on top rack
Measuring Cup			If dishwashing, place on top rack
Food Tamper			If dishwashing, place on top rack
Strainer Bag			Turn inside out when cleaning, and spread open to dry
Cleaning Brush			Use to clean under blades in pitcher
Glass Pitcher		✓	<ul style="list-style-type: none"> Do not wet bottom side of pitcher Ensure bottom of pitcher is dry before placing it on blender base Do not attempt to remove blade assembly from pitcher Do not store food or non-food items in the pitcher
Blender Base			<ul style="list-style-type: none"> Unplug and wipe clean with a soft, damp cloth Never fold the power cord

⚠ WARNING

The pitcher and base have electrical components and may cause risk of shock if wet.

⚠ WARNING

			
Do not immerse pitcher in water or other liquid, and do not cycle through dishwasher.	Do not immerse blender base in water other liquid, and do not cycle through dishwasher.	Do not immerse power cord at any time.	Do not wet prongs of power cord.

Clean Program

Pulse Cleaning

Use **Clean** program to remove superficial food debris and residue from pitcher.

Follow steps 2-8 in “**Getting Started**” section of this manual.

For stubborn food residue, refer to “**Deep Cleaning**” section below.

Deep Cleaning

Minerals in water may deposit at bottom of pitcher. Periodic deep cleaning will ensure the blender’s longevity.

1. Add 1 cup (8 oz / 250 mL) white vinegar or citric acid, and 1 cup (8 oz / 250 mL) of warm water to pitcher.
2. Allow solution to sit for at least one hour.
3. Connect power cord to a 120V power source.
4. Place lid on pitcher and turn lid clockwise until it clicks into place. Lid braces must fit over glass lid brace catches, located on pitcher.
5. Place pitcher on blender base.
6. If the food residue is especially stubborn, select **Soup**.
7. Touch **Start** to heat water to boiling. Once water is hot, touch **Cancel**.
8. Touch **Clean**.
9. Touch **Start** to begin pulse motion cleaning.

WARNING

Blades are sharp. To avoid the risk of severe injury, unplug blender before inserting cleaning brush into pitcher.



INSTANT TIP: Stubborn Stains

Follow steps 1-3 above. Then, with blender unplugged, scrub with the cleaning brush or a sponge, and rinse. Repeat as necessary.

Troubleshooting

Register your product today at instantappliances.com/support/register

Problem		Possible Reason	Solution
Contents stop blending (unit is still powered ON)		Contents are too thick	<ul style="list-style-type: none"> • Add liquid to recipe - do not fill above max fill lines as indicated on the pitcher • Use the food tamper to agitate contents • Use Pulse program
Blender will not power ON		Power cord not fully inserted into outlet	<ul style="list-style-type: none"> • Ensure the cord is plugged fully into a 120V outlet • Check blender on a different outlet
		Pitcher is not placed on base	Pitcher must be on base to turn on
		Lid is not fully closed	Place lid on pitcher and turn lid clockwise until it clicks into place
		Fuse has blown	Contact the Customer Care Team
Error Indicator blinks and error code appears on display	E01	Motor overheated; may have run for too long	<ul style="list-style-type: none"> • Remove and re-seat pitcher • Add thin liquid to pitcher • Use the food tamper to ease blending of thicker foods
		Ingredients may be too thick	<ul style="list-style-type: none"> • Remove and re-seat pitcher • Add thin liquid to pitcher - do not fill above max fill lines as indicated on the pitcher • Use the tamper to ease blending of thicker foods
	E02	Temperature sensor error	<ul style="list-style-type: none"> • Remove and re-seat pitcher • Contact Customer Care Team • Allow the blender to rest for 5 minutes between blending hot items and blending cold items
	E03	High or dry heat detected	<ul style="list-style-type: none"> • Remove and re-seat pitcher • Add liquid when using a cooking function
	E07	Motor is too hot	Unplug and allow the blender to cool before using again
	"Lid"	Lid not secure	Remove and reposition the lid on the pitcher
Results are too watery		Food is over-processed	<ul style="list-style-type: none"> • Use Pulse to prevent over-blending • Shorten processing time
		Too much liquid	Reduce liquid in recipe
Smokey smell on initial use		First heating of protective non-toxic substance that was applied to element during manufacturing	No action needed; this can occur on first use – it is normal and is harmless
White, bluish or rainbow discoloration on steel in pitcher		Minerals may have deposited at the bottom of the pitcher	Deep Clean the pitcher as outlined in Care & Cleaning

Warranty

Limited Warranty

This Limited Warranty is effective for one year from the date of original consumer purchase. Proof of original purchase date and, if requested by an authorized representative of Instant Brands Inc. ("Instant Brands"), return of your appliance, is required to obtain service under this Limited Warranty. Provided that this appliance is operated and maintained in accordance with written instructions attached to or furnished with the appliance, Instant Brands will, in its sole and exclusive discretion, either: (i) repair defects in materials or workmanship; or (ii) replace the appliance. In the event that your appliance is replaced, the Limited Warranty on the replacement appliance will expire 12 months from the date of original consumer purchase.

This Limited Warranty extends only to the original purchaser and use of the appliance in the United States of America and Canada. This warranty does not cover units that are used outside of the United States of America and Canada.

Any modification or attempted modification to your appliance may interfere with the safe operation of the appliance and will void this Limited Warranty. This Limited Warranty does not apply in respect of any appliance or any part thereof that has been altered or modified unless such alterations or modifications were expressly authorized by an Instant Brands representative.

Limitation and Exclusions

The liability of Instant Brands, if any, for any allegedly defective appliance or part shall in no circumstances exceed the purchase price of a comparable replacement appliance.

This Limited Warranty does not cover:

1. Damage resulting from accident, alteration, misuse, abuse, neglect, unreasonable use, use contrary to the operating instructions, normal wear and tear, commercial use, improper assembly, disassembly, failure to provide reasonable and necessary maintenance, fire, flood, acts of God or repair by anyone unless directed by an Instant Brands Representative;
2. Repairs where your appliance is used for other than normal, personal use or when it is used in a manner that is contrary to published user or operator instructions; or
3. Use of unauthorized parts and accessories, or repairs to parts and systems resulting from unauthorized repairs or modifications made to this appliance.

The cost of repair or replacement under these excluded circumstances shall be borne by you.

Warranty

Disclaimer of Implied Warranties

EXCEPT AS EXPRESSLY PROVIDED HEREIN AND TO THE EXTENT PERMITTED BY LAW, INSTANT BRANDS MAKES NO WARRANTIES, CONDITIONS OR REPRESENTATIONS, EXPRESS OR IMPLIED, BY STATUTE, USAGE, CUSTOM OF TRADE OR OTHERWISE WITH RESPECT TO THE APPLIANCES OR PARTS COVERED BY THIS WARRANTY, INCLUDING BUT NOT LIMITED TO, WARRANTIES, CONDITIONS, OR REPRESENTATIONS OF WORKMANSHIP, MERCHANTABILITY, MERCHANTABLE QUALITY, FITNESS FOR A PARTICULAR PURPOSE OR DURABILITY.

Some states or provinces do not allow for the exclusion of implied warranties of merchantability or fitness, so this limitation may not apply to you. In these states and provinces, you have only the implied warranties that are expressly required to be provided in accordance with applicable law.

Limitation of Remedies; Exclusion of Incidental and Consequential Damage

YOUR SOLE AND EXCLUSIVE REMEDY UNDER THIS LIMITED WARRANTY SHALL BE APPLIANCE REPAIR OR REPLACEMENT AS PROVIDED HEREIN. INSTANT BRANDS SHALL NOT BE LIABLE FOR INDIRECT, INCIDENTAL OR CONSEQUENTIAL DAMAGES ARISING OUT OF OR IN CONNECTION WITH THE USE OR PERFORMANCE OF THE APPLIANCE OR DAMAGES WITH RESPECT TO ANY ECONOMIC LOSS, PERSONAL INJURY, LOSS OF PROPERTY, LOSS OF REVENUES OR PROFITS, LOSS OF ENJOYMENT OR USE, COSTS OF REMOVAL, INSTALLATION OR OTHER INDIRECT, INCIDENTAL OR CONSEQUENTIAL DAMAGES OF ANY NATURE OR KIND.

Warranty Registration

Please visit www.instantappliances.com/support/register to register your new Instant Brands™ appliance and validate your warranty within thirty (30) days of purchase. You will be asked to provide the store name, date of purchase, model number (found on the back of your appliance) and serial number (found on the bottom of your appliance) along with your name and email address. The registration will enable us to keep you up to date with product developments, recipes and contact you in the unlikely event of a product safety notification. By registering, you acknowledge that you have read and understand the instructions for use, and warnings set forth in the accompanying instructions.

Warranty Service

To obtain service under this warranty, please contact our Customer Service Department by phone at 1-800-828-7280 or by email to support@instantappliances.com. You can also create a support ticket online at www.instantappliances.com/support. If we are unable to resolve the problem, you may be asked to send your appliance to the Service Department for quality inspection. Instant Brands is not responsible for shipping costs related to warranty service, save and except for shipping costs associated with the return of your appliance from Canada or within the 48 contiguous states and the District of Columbia of the United States of America, as provided herein. When returning your appliance, please include your name, mailing address, email address, phone number, and proof of the original purchase date as well as a description of the problem you are encountering with the appliance.

Instant™

Instant Brands Inc.
11 - 300 Earl Grey Dr. Suite 383
Ottawa, Ontario
K2T 1C1
Canada

Register your product today at:

instantappliances.com/support/register

 1-800-828-7280

 store.instantappliances.com

 support@instantappliances.com

 instantappliances.com

 instantappliances.com/#chat

 [@instantpot](https://www.facebook.com/instantpot)

 [@theinstantpot](https://www.youtube.com/theinstantpot)

 [@instantpotofficial](https://www.instagram.com/instantpotofficial)

 [@instantpot](https://www.pinterest.com/instantpot)

 [@instantpot](https://www.twitter.com/instantpot)

Copyright © 2019 Instant Brands™ Inc

671-0101-61